

705nm~710nm 10mW Single Mode Coaxial Pigtailed Laser Diode with SMF | Built-in PD
705nm 10mW SM Fiber Coupled LD with Single Mode Fiber (SM Fiber) |4um SMF | With Photodiode
RWLP-705-010m-4-PD

705nm Pigtailed Diode Laser		10mW/SM Fiber	
PARAMETER	SYMBOL	VALUE	UNIT
Reverse Voltage	V_r	2.0	V
Operating Temperature	T_{op}	-10~+60	°C
Storage Temperature	T_{stg}	-40~+85	°C
Lead soldering temperature (10 sec.)	T_{is}	260	°C
Features: <ul style="list-style-type: none"> • 705nm • With SM Fiber • Coaxial or B82 Package • Built-in PD 			
Applications: <ul style="list-style-type: none"> • Medical Laser Treatment • Others 			
Specifications	RWLP-705-010m-4-PD		
	Min	Type	Max
Center Wavelength@25°C	705nm±10nm		
Recommended Operating Temperature	25°C		
Output Power	----	10mW	----
Fiber Type	Single Mode Fiber		
Fiber Core	4um		
Monitor Current	----	0.3mA	----
PD Reverse Voltage	----	----	30V
Fiber Connector	FC/SC/SMA905		
Fiber Length	>80cm		
Threshold Current (Typ.)	----	25mA	60mA
Operating Current (Typ.)	----	70mA	80mA
Operating Voltage	----	2.4V	3.0V
Package Style	Coaxial or B82		
Photodiodes	Built-in		

Coaxial Package View: (Part Number: RWLP-705-010m-4-PD)

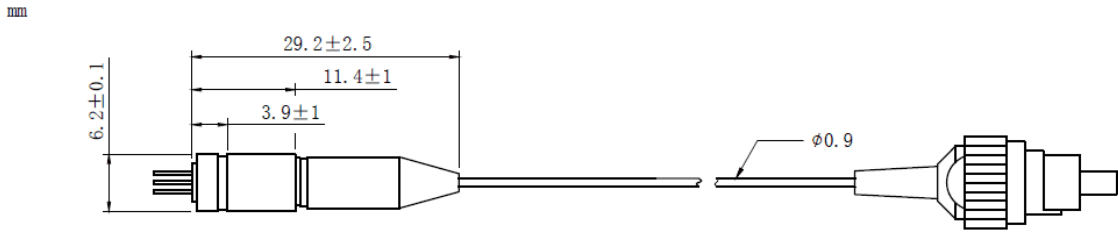

B82 Package View: (Part Number: RWLP-705-010m-4-B-PD)

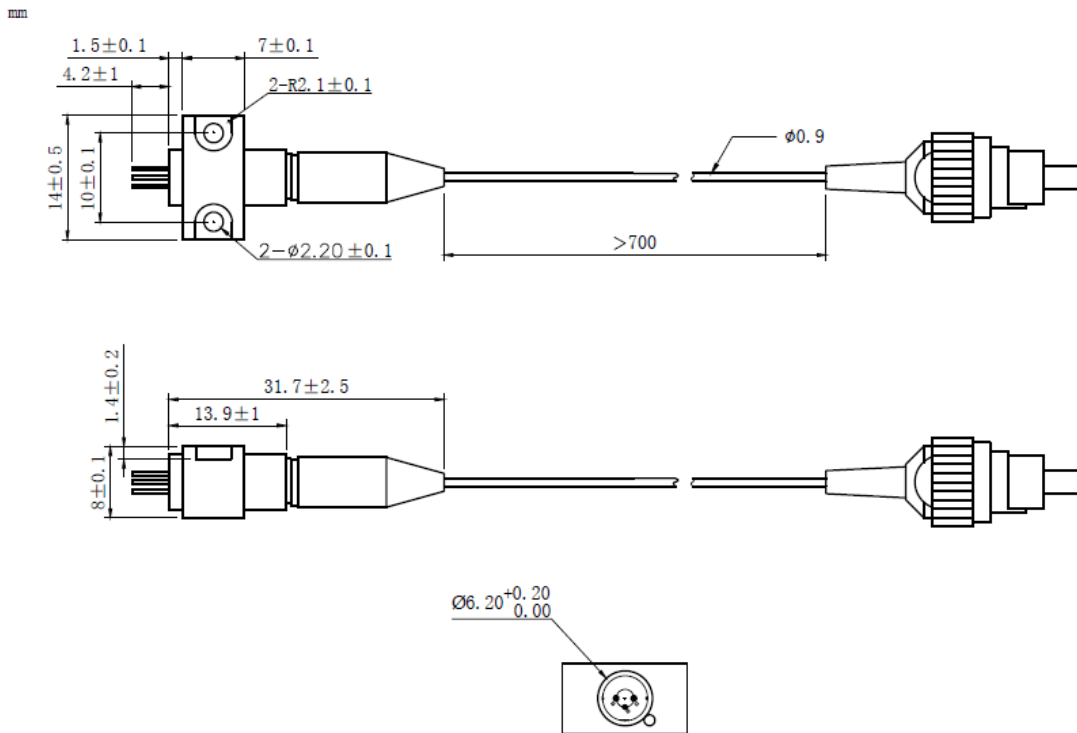

PIN Bottom View:

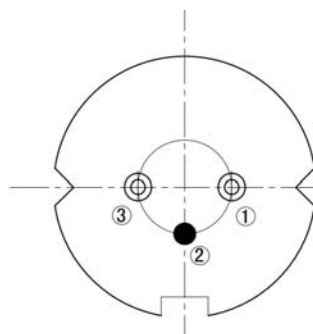

1	LD(-)
2	LD(+)& PD(-)
3	PD(+)

Electrically shorten LD module and store in non-extreme conditions.
Suggest using the constant current power supply.

