

DATASHEET

1550nm SLED
14-Pin Butterfly Package

Part# ASM002006

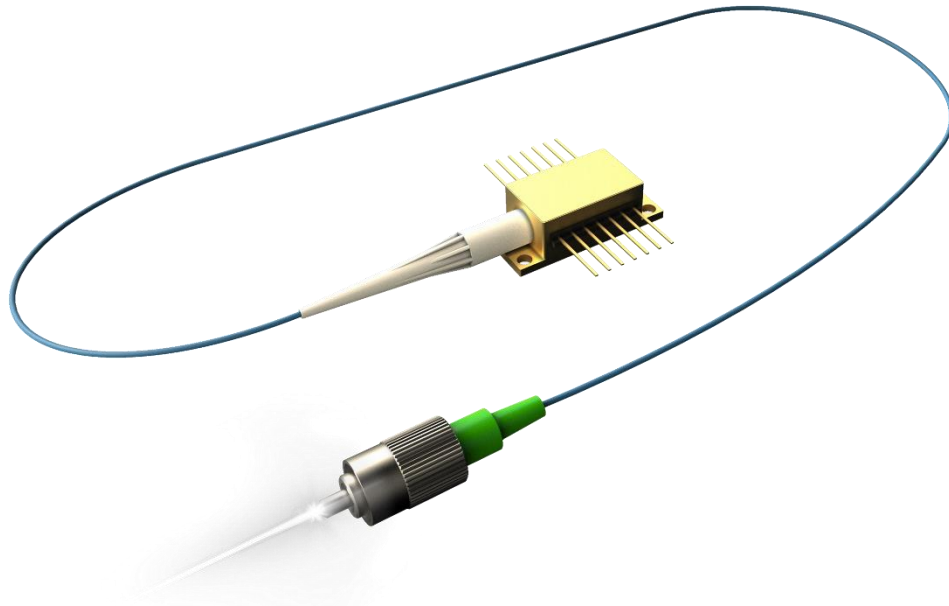

A. PRODUCT DESCRIPTION

This solution is a superluminescent diode (SLED) that comes in a 14-pin butterfly package, and operates within the near-infrared region (NIR). It is a compact package that provides an integrated optical interface and one of the highest power densities within the SLED technology industry.

This package offers spectral coverage from 1515nm to 1585nm, with up to 15mW of optical power. The temperature of the device is regulated by an integrated thermoelectric cooler (TEC). This light source is robust and easy-to-use, making it an appropriate fit for many different types of manufactured assemblies requiring light power, including the applications below:

B. KEY FEATURES

- SLED can be run from 0 – 100% of maximum rating
- Output power: >15mW
- Bandwidth FWHM: 70nm
- Light output: FC/APC Connector (Optional: FC/PC or SMA)
- SLED comes with a built-in independent monitor photodiode and one thermoelectric cooler (TEC)

C. APPLICATIONS

- Optical Component Testing
- Telecom Test Equipment
- Medical Optical Coherence Tomography
- Industrial Optical Coherence Tomography
- Metrology
- Fiber Optic Gyroscopes
- Biomedical Imaging Systems
- Optical Sensing
- White Light Interferometry & Chromatic Dispersion
- Research and Development

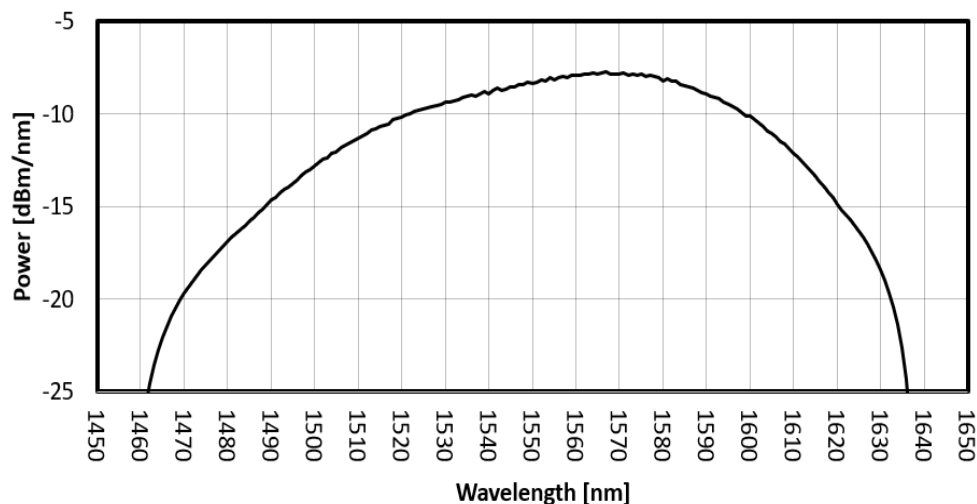

D. ABSOLUTE MAXIMUM RATINGS (see note 1)

| Parameter | Symbol | Condition | Min. | Max. | Unit |
|--------------------------------------|--------------|---|------|------|--------------------|
| Reverse Voltage | V_R | CW | - | 2 | V |
| Operating Current | I_{OP} | CW $T_{OP} = 25^{\circ}\text{C}$ $T_{TEC} = 21^{\circ}\text{C}$ | - | 550 | mA |
| Forward Voltage | V_F | CW $T_{OP} = 25^{\circ}\text{C}$ $T_{TEC} = 21^{\circ}\text{C}$ | - | 3.0 | V |
| BTF Package Temperature (see note 2) | T_{BTF} | - | -40 | 80 | $^{\circ}\text{C}$ |
| SLED Operating Temperature | T_{SLED} | I_{OP} | 0 | 70 | $^{\circ}\text{C}$ |
| TEC Current | I_{TEC} | - | - | 2.6 | A |
| TEC Voltage | V_{TEC} | - | - | 3.56 | V |
| TEC Temperature (see note 3) | T_{TEC} | - | 0 | 50 | $^{\circ}\text{C}$ |
| Storage Temperature (see note 4) | T_{stg} | No condensation, Unbiased | -40 | 85 | $^{\circ}\text{C}$ |
| Storage Humidity (see note 4) | RH_{stg} | - | 5 | 85 | %RH |
| Electro Static Discharge (ESD) | V_{ESD} | Human Body Model | - | 500 | V |
| Lead Soldering Temperature | T_{Solder} | - | - | 260 | $^{\circ}\text{C}$ |
| Lead Soldering Time | t_{Solder} | - | - | 10 | s |

Notes:

1. Please note that exceeding the Absolute Maximum Ratings above may cause device failure. The manufacturer does not bear responsibility for laser power damage that is attributed to electrostatic discharge, excessive current levels, and current spikes (transients).

Any attempts to increase the laser drive current above the pre-set limits or recommended specification limits, can damage the device, and nullify the warranty period. It should be emphasized that the current limit set points cannot be exceeded.
2. For optimum performance of the SLED, the SLED must be operated within the specified temperature ranges. The SLED has an internal thermoelectric cooler (TEC) but it's always required to mount the butterfly package on an appropriate heatsink, capable of dissipating up to 7W.
3. T_{TEC} is monitored by internal thermistor with external readout.
4. Storage temperature and relative humidity should be chosen so the dew point of the humid air around the package is below the storage temperature of the package, to avoid condensation on the package.

E. OPTICAL AND ELECTRICAL SPECIFICATIONS (see note 5)

| Parameter | Symbol | Condition | Min. | Typ. | Max. | Unit |
|--|--------------------|---|-------|----------------|-------|------|
| Center Wavelength (see note 6) | CWL | CW T _{OP} = 25°C T _{TEC} = 21°C I _{OP} | 1540 | 1550 | 1560 | nm |
| Operating Current | I _{OP} | CW T _{OP} = 25°C T _{TEC} = 21°C I _{OP} | - | - | 500 | mA |
| Forward Voltage | V _F | CW T _{OP} = 25°C T _{TEC} = 21°C I _{OP} | - | - | 2.5 | V |
| PM Fiber Coupled Power | P | CW T _{OP} = 25°C T _{TEC} = 21°C I _{OP} | 15 | - | - | mW |
| Bandwidth FWHM (see note 7) | B _{FWHM} | CW T _{OP} = 25°C T _{TEC} = 21°C I _{OP} | 70 | - | - | nm |
| Bandwidth @-10dB | B@10dB | CW T _{OP} = 25°C T _{TEC} = 21°C I _{OP} | - | 130 | - | nm |
| Spectral Coverage | SC | CW T _{OP} = 25°C T _{TEC} = 21°C I _{OP} | - | 1515 – 1585 | - | nm |
| Spectrum Ripple (see note 8) | R | CW T _{OP} = 25°C T _{TEC} = 21°C I _{OP} | <0.15 | <0.30 | <0.45 | dB |
| Polarization Extinction Ratio (see note 9) | PER | CW T _{OP} = 25°C T _{TEC} = 21°C I _{OP} | 10 | - | - | dB |
| Thermistor Resistance TEC | R _{THTEC} | T _{OP} = 25°C T _{TEC} = 21°C | 9.5 | 10.0 | 10.5 | kΩ |
| Power Dissipation (see note 10) | P _{DISS} | I _{OP} | - | 5 | - | W |
| TEC Voltage | V _{TEC} | - | - | - | 2.8 | V |
| TEC Current | I _{TEC} | - | - | - | 1.4 | A |

Notes:

5. There may be differences in typical values of output power, power stability, wavelength and bandwidth, due to coupling efficiency. These values are references and there is no guarantee that each particular SLED module will have EXACTLY the typical values shown on the previous chart. The specification lists the operating temperature for the electrical/optical characteristics, which is the temperature of the SLED during the time that the specifications were measured. Variation in temperature beyond what is specified can have a significant effect on the optical characteristics, like changes in wavelength or drop in output power.
6. Center Wavelength is defined as the center point of the 3dB bandwidth of the SLED.
7. SLED FWHM is defined as the -3dB bandwidth from the center wavelength.
8. Resolution of 0.1nm.
9. Polarization Extinction Ratio is defined as the ratio of optical powers of perpendicular polarizations, expressed in decibels (dB).
10. Power dissipation when SLED is on and |T_{BTF} - T_{TEC}| is 40°C.

F. PLOTS – Test performed at $T_{OP}=25^{\circ}\text{C}$ and $T_{TEC}=21^{\circ}\text{C}$

FIG. 1: BTF PACKAGE SPECTRUM

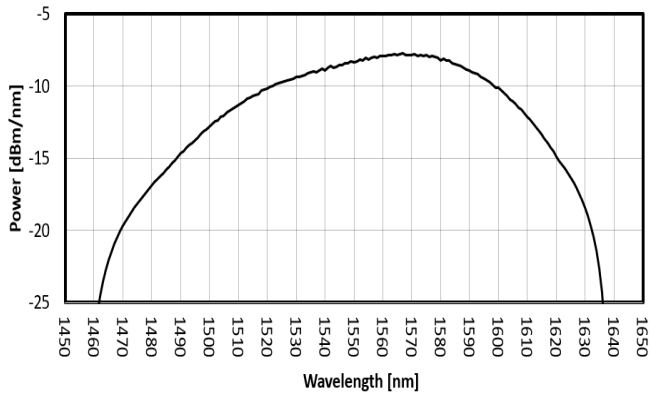

FIG. 2: BTF PACKAGE OUTPUT POWER VS CURRENT

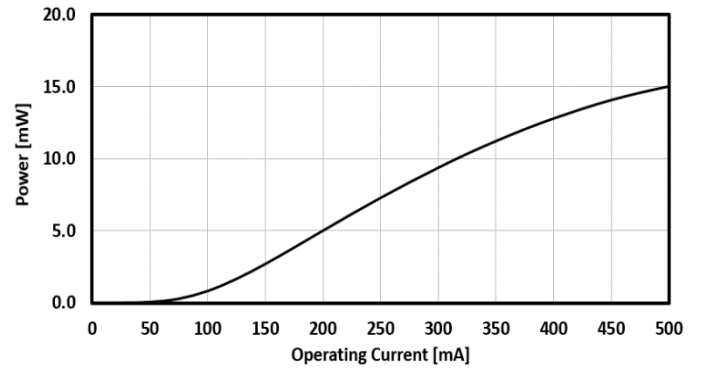

FIG. 3: BTF PACKAGE FORWARD VOLTAGE VS CURRENT

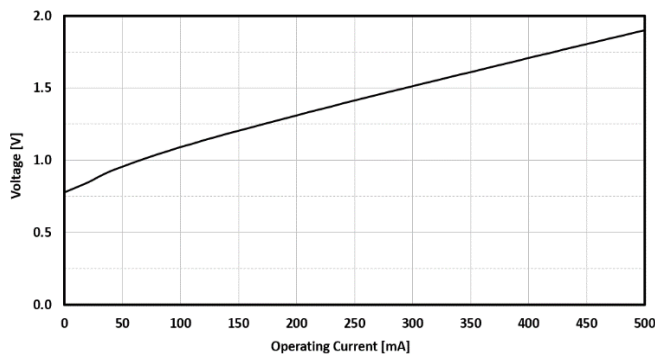
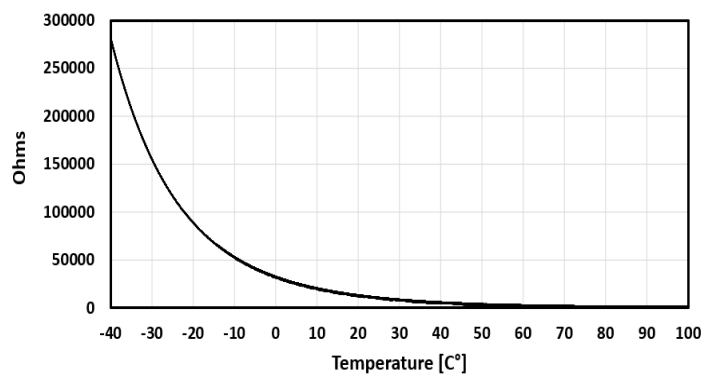
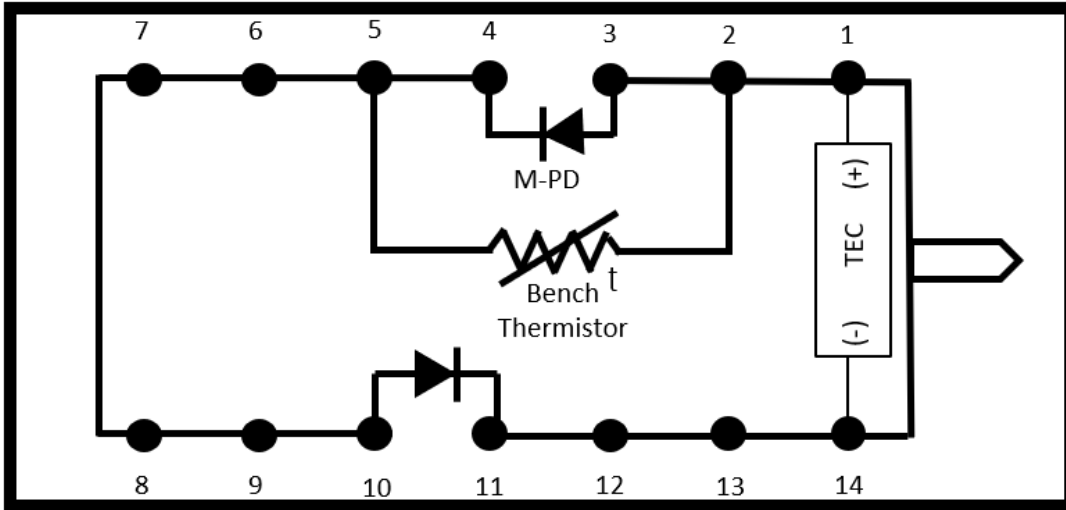

FIG. 4: THERMISTOR R_{THTEC} RESISTANCE VS TEMP.



G. PIN OUT

| External Pin Assignment | | | |
|-------------------------|------------------|----|------------------|
| 1 | TEC + | 8 | NC |
| 2 | THERMISTOR | 9 | NC |
| 3 | M-PD ANODE (+) | 10 | SLEAD ANODE (+) |
| 4 | M-PD CATHODE (-) | 11 | SLED CATHODE (-) |
| 5 | THERMISTOR | 12 | NC |
| 6 | NC | 13 | CASE GND |
| 7 | NC | 14 | TEC - |



H. MECHANICAL DIAGRAM

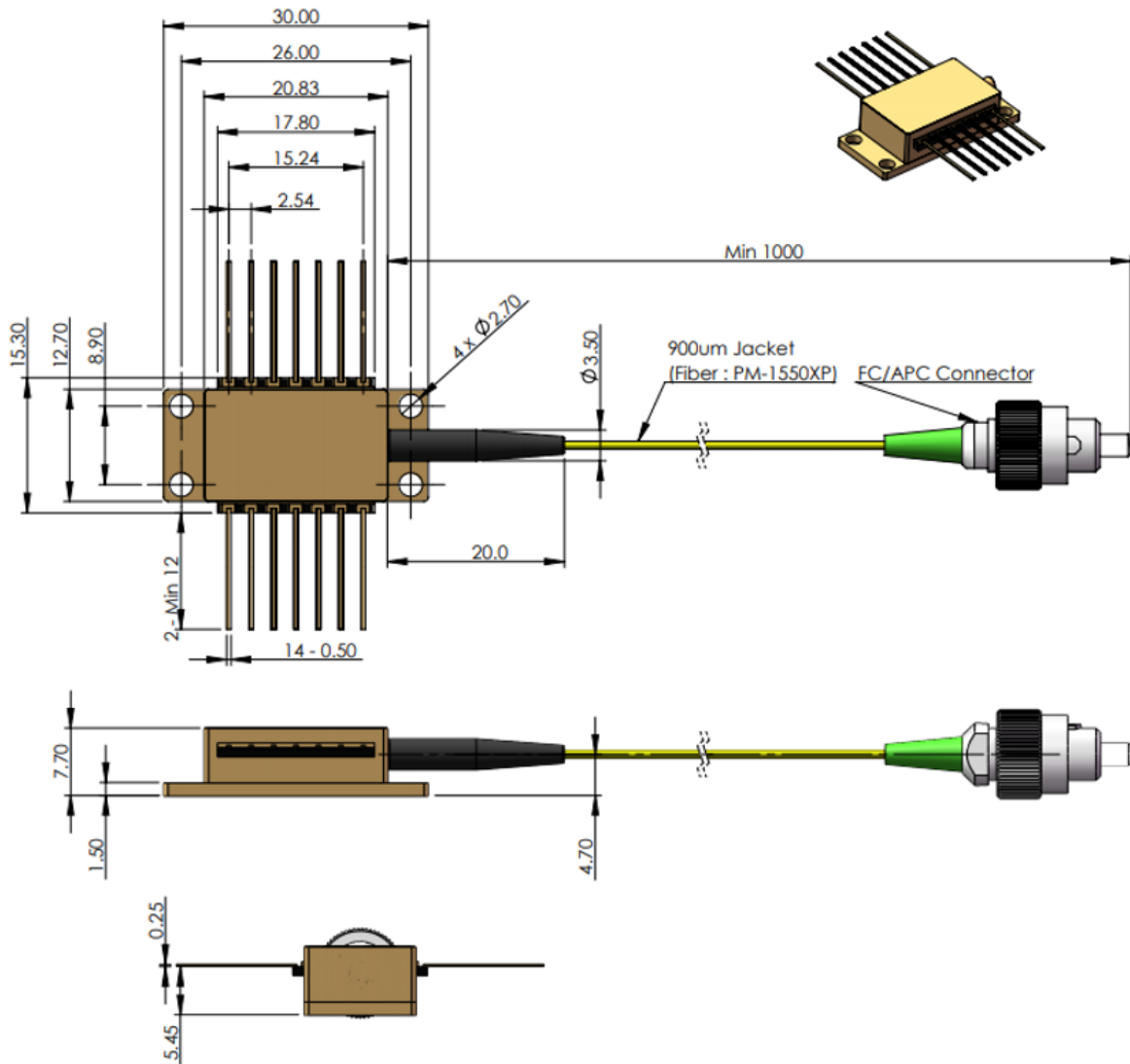

| Part | Description |
|----------------------|------------------|
| Package type | 14-pin Butterfly |
| Fiber: | PM-1550XP |
| Core Diameter | 8.5µm |
| Cladding Diameter | 125µm |
| Coating Diameter | 245µm |
| Jacket | 900µm loose tube |
| Fiber pigtail length | 1m |
| Fiber bending radius | >40mm |
| Connector | FC/APC |
| Dimensions | See figure |

I. MOUNTING RECOMMENDATIONS:

The SLED can be mounted on a flat cooling surface without having to risk forming the pins. Mounting surface should be flat, with no physical obstructions underneath to cause any discontinuity in the surface flatness. If a heatsink is used, the base of the butterfly package will rest on the surface of a heatsink in order to cool the internal TEC.

Maximum torque to avoid damage to the device is 13 lb.in. /1.5 Nm. Minimum torque is 9 lb.in/1.1 nm. Do not use self-tapping screws. This light source should be mounted so that mechanical vibrations cannot cause short circuits between leads. AZIMUTH 7 pin, 0.100" pitch Sockets are recommended. The 14 pins will rest on a pair of spring-loaded sockets and be squeezed between the contacts and a plastic clamp.

J. SAFETY

All statements regarding safety of operation and technical data will only apply when the unit is operated correctly.

This SLED is a Class 1M laser product. It is safe for all conditions of use except when passed through magnifying optics such as microscopes and telescopes. It produces a beam that is divergent. If light is re-focused use protective eye wear.

K. ORDERING CODE

| ORDERING CODE: | | BTF | SLEDs | FT | DOP | SC | FWHM | CW | LOP |
|----------------|---|-----|-------|----|-----|----|------|----|-----|
| BTF | 14-Pin Butterfly Package SLED | | | | | | | | |
| SLEDs | SLED center wavelength, choose one of the following models: 1300nm, 1340nm, 1390nm, 1430nm, 1480nm, 1550nm, 1615nm, 1680nm | | | | | | | | |
| FT | Fiber Type, choose 1: PM: Polarization Maintaining SM: Single Mode | | | | | | | | |
| DOP | Degree of Polarization HP: High Degree of Polarization | | | | | | | | |
| SC | Spectral Coverage [nm] | | | | | | | | |
| FWHM | Full Width Half Maximum [nm] [FWHM defined as the bandwidth from the lowest spectral dip] | | | | | | | | |
| CW | Center Wavelength [nm] | | | | | | | | |
| LOP | Light Output Power [mW] | | | | | | | | |

| |
|--|
| Product Code |
| Available Options |
| Taken From Table |

| Part Number | Ordering Code: LTC-OSE1-(SLED)-(FT)-(DOP)-(SC)-(FWHM)-(CW)-(LOP) | SLED [nm] | FT | SC [nm] | FWHM [nm] | CW [nm] | LOP [mW] |
|-------------|--|-----------|----|-----------|-----------|---------|----------|
| ASM002001 | BTF-1300-PM-HP-1270_1330-60-1300-12 | 1300 | PM | 1270-1330 | 60 | 1300 | 12 |
| ASM002002 | BTF-1340-PM-HP-1310_1370-60-1340-12 | 1340 | PM | 1310-1370 | 60 | 1340 | 12 |
| ASM002003 | BTF-1390-PM-HP-1360_1420-60-1390-10 | 1390 | PM | 1360-1420 | 60 | 1390 | 10 |
| ASM002004 | BTF-1430-PM-HP-1410_1450-40-1430-10 | 1430 | PM | 1410-1450 | 40 | 1430 | 10 |
| ASM002005 | BTF-1480-PM-HP-1455_1505-50-1480-13 | 1480 | PM | 1455-1505 | 50 | 1480 | 13 |
| ASM002006 | BTF-1550-PM-HP-1515_1585-70-1550-15 | 1550 | PM | 1515-1585 | 70 | 1550 | 15 |
| ASM002007 | BTF-1615-PM-HP-1585_1645-60-1615-6 | 1615 | PM | 1585-1645 | 60 | 1615 | 6 |
| ASM002008 | BTF-1680-PM-HP-1655_1705-50-1680-13 | 1680 | PM | 1655-1705 | 50 | 1680 | 13 |
| ASM002009 | BTF-1550-PM-HP-1500_1600-70-1550-8 | 1550 | PM | 1500-1600 | 70 | 1550 | 8 |
| ASM002012 | BTF-1550-PM-HP-1532_1568-35-1550-30 | 1550 | PM | 1532-1568 | 35 | 1550 | 30 |

| Part Number | Ordering Code: LTC-OSE1-(SLED)-(FT)-(DOP)-(SC)-(FWHM)-(CW)-(LOP) | SLED [nm] | FT | SC [nm] | FWHM [nm] | CW [nm] | LOP [mW] |
|-------------|--|-----------|----|-----------|-----------|---------|----------|
| ASM002101 | BTF-1300-SM-HP-1270_1330-60-1300-12 | 1300 | SM | 1270-1330 | 60 | 1300 | 12 |
| ASM002102 | BTF-1340-SM-HP-1310_1370-60-1340-12 | 1340 | SM | 1310-1370 | 60 | 1340 | 12 |
| ASM002103 | BTF-1390-SM-HP-1360_1420-60-1390-10 | 1390 | SM | 1360-1420 | 60 | 1390 | 10 |
| ASM002104 | BTF-1430-SM-HP-1410_1450-40-1430-10 | 1430 | SM | 1410-1450 | 40 | 1430 | 10 |
| ASM002105 | BTF-1480-SM-HP-1455_1505-50-1480-13 | 1480 | SM | 1455-1505 | 50 | 1480 | 13 |
| ASM002106 | BTF-1550-SM-HP-1515_1585-70-1550-15 | 1550 | SM | 1515-1585 | 70 | 1550 | 15 |
| ASM002107 | BTF-1615-SM-HP-1585_1645-60-1615-6 | 1615 | SM | 1585-1645 | 60 | 1615 | 6 |
| ASM002108 | BTF-1680-SM-HP-1655_1705-50-1680-13 | 1680 | SM | 1655-1705 | 50 | 1680 | 13 |
| ASM002109 | BTF-1550-SM-HP-1500_1600-70-1550-8 | 1550 | SM | 1500-1600 | 70 | 1550 | 8 |
| ASM002112 | BTF-1550-SM-HP-1532_1568-35-1550-30 | 1550 | SM | 1532-1568 | 35 | 1550 | 30 |