

DATASHEET

Multi-Channel Superluminescent Diode Source

Optical Spectral Engine (OSE2)

**32 Pin-Butterfly Package, 4 SLEDs: 1480nm, 1550nm, 1615nm, 1680nm, PM
Fiber, High Degree of Polarization, Spectral Coverage: 1435nm-1725nm, FWHM:
290nm, CW: 1580nm, Light Output Power >25mW**

Luxmux Part Number: ASM000005

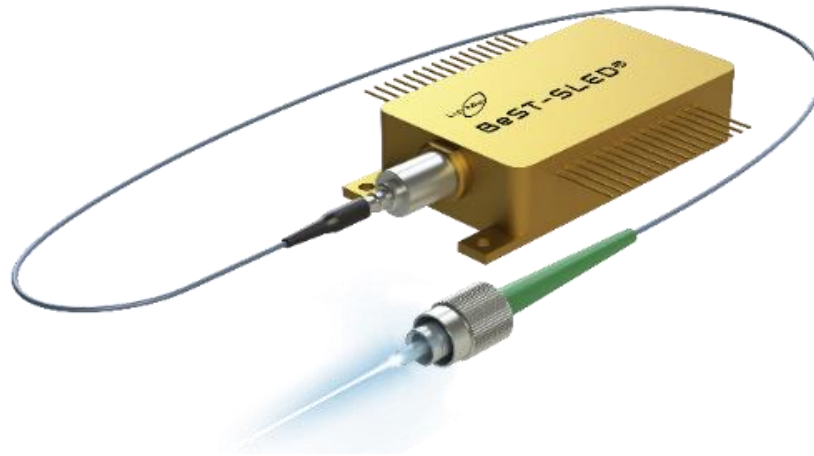

A. PRODUCT DESCRIPTION

The Optical Spectral Engine (OSE2) ASM000005 is a broadband superluminescent diode (SLED) light source that operates within the near-infrared (NIR) region. It is a compact 32-pin butterfly package that provides an integrated optical interface and one of the highest power-density within the SLED technology industry.

This SLED offers spectral coverage from 1435nm to 1725nm, with up to 25mW of optical power. The temperature of the device is regulated by an integrated thermoelectric cooler (TEC). This light source is compact and easy to use, making it an appropriate fit for many different types of manufactured assemblies requiring light power, including the applications below:

B. KEY FEATURES

- Four superluminescent diodes (SLEDs)
- All SLEDs can be run from 0 – 100% of maximum rating
- Output power: >25mW
- Bandwidth FWHM: 290nm
- Light output: FC/APC Connector (Optional FC/PC or SMA)
- Luxmux’s patented technology for spectral stitching provides optimum power and bandwidth
- Each SLED comes with a built-in independent monitor photodiode and one common thermoelectric cooler (TEC) for all SLEDs

C. APPLICATIONS

- Optical Component Testing
- Telecom Test Equipment
- Medical Optical Coherence Tomography
- Industrial Optical Coherence Tomography
- Metrology
- Biomedical Imaging Systems
- Optical Sensing
- White Light Interferometry & Chromatic Dispersion
- Research and Development

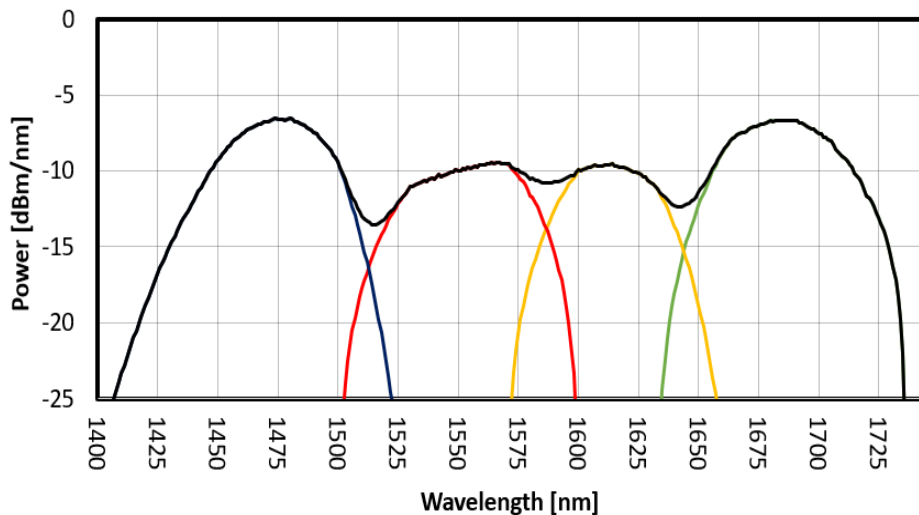



D. ABSOLUTE MAXIMUM RATINGS (see note 1)

| Parameter | Symbol | Condition | Min. | Max. | Unit |
|---|--------------|---|--------------------------|--------------------------|-------------|
| Reverse Voltage (All SLEDs) | V_R | CW | - | 2 | V |
| Operating Current SLED 1 – 1680nm SLED 2 – 1615nm SLED 3 – 1550nm SLED 4 – 1480nm | I_{OP} | CW $T_{OP} = 25^{\circ}C$ $T_{TEC} = 21^{\circ}C$ | - | 450 350 550 400 | mA |
| Forward Voltage SLED 1 – 1680nm SLED 2 – 1615nm SLED 3 – 1550nm SLED 4 – 1480nm | V_F | CW $T_{OP} = 25^{\circ}C$ $T_{TEC} = 21^{\circ}C$ | - | 3.0 2.5 3.0 2.5 | V |
| Ambient Operating Temperature SLED 1 – 1680nm SLED 2 – 1615nm SLED 3 – 1550nm SLED 4 – 1480nm | T_{OP} | I_{OP} | -40 -40 -40 -40 | 65 70 60 70 | $^{\circ}C$ |
| OSE2 Package Temperature (see note 2) | T_{OSE2} | | -40 | 80 | $^{\circ}C$ |
| SLED Operating Temperature (see note 3) | T_{SLED} | I_{OP} | 0 | 70 | $^{\circ}C$ |
| TEC Current | I_{TEC} | | - | 10 | A |
| TEC Voltage | V_{TEC} | | - | 9 | V |
| TEC Temperature | T_{TEC} | | 0 | 50 | $^{\circ}C$ |
| Storage Temperature (see note 4) | T_{stg} | No condensation, Unbiased | -40 | 85 | $^{\circ}C$ |
| Storage Humidity (see note 4) | RH_{stg} | | 5 | 85 | %RH |
| Electro Static Discharge (ESD) | V_{ESD} | Human Body Model | - | 500 | V |
| Lead soldering temperature | T_{Solder} | | - | 280 | $^{\circ}C$ |

Notes:

1. Please note that exceeding the Absolute Maximum Ratings above may cause device failure. Luxmux does not bear responsibility for laser power damage that is attributed to electrostatic discharge, excessive current levels, and current spikes (transients).

Any attempts to increase the laser drive current above the pre-set limits or recommended specification limits, can damage the device, and nullify the warranty period. It should be emphasized that the current limit set points cannot be exceeded.
2. For optimum performance of the Optical Spectral Engine (OSE2), the OSE2 must be operated within the specified temperature ranges. The BeST-SLED has an internal thermoelectric cooler (TEC) but it's always required to mount the OSE2 on an appropriate heatsink, capable of dissipating up to 15W.
3. T_{TEC} is monitored by internal thermistor with external readout.
4. Storage temperature and relative humidity should be chosen so the dew point of the humid air around the package is below the storage temperature of the package, to avoid condensation on the package.



E. OPTICAL AND ELECTRICAL SPECIFICATIONS (see note 5)

| Parameter | Symbol | Condition | Min. | Typ. | Max. | Unit |
|---|-------------|--|--------------------------------------|--------------------------------------|--------------------------------------|-------|
| Center wavelength (see note 6) SLED 1 – 1680nm SLED 2 – 1615nm SLED 3 – 1550nm SLED 4 – 1480nm SLED 1+2+3+4 – 1580nm | CWL | CW $T_{OP} = 25^{\circ}C$ $T_{TEC} = 21^{\circ}C$ | 1670 1605 1540 1470 1570 | 1680 1615 1550 1480 1580 | 1690 1625 1560 1490 1590 | nm |
| Operating Current SLED 1 – 1680nm SLED 2 – 1615nm SLED 3 – 1550nm SLED 4 – 1480nm | I_{OP} | CW $T_{OSE2} = 25^{\circ}C$ $T_{TEC} = 21^{\circ}C$ | - | - | 400 300 500 350 | mA |
| Forward Voltage SLED 1 – 1680nm SLED 2 – 1615nm SLED 3 – 1550nm SLED 4 – 1480nm | V_F | CW $T_{OSE2} = 25^{\circ}C$ $T_{TEC} = 21^{\circ}C$ | - | - | 2.0 2.0 2.5 2.0 | V |
| PM Fiber Coupled Power SLED 1 – 1680nm SLED 2 – 1615nm SLED 3 – 1550nm SLED 4 – 1480nm SLED 1+2+3+4 – 1580nm | P | CW $T_{OP} = 25^{\circ}C$ $T_{TEC} = 21^{\circ}C I_{OP}$ | - | 8 4 5 8 25 | - | mW |
| Bandwidth FWHM (see note 7) SLED 1 – 1680nm SLED 2 – 1615nm SLED 3 – 1550nm SLED 4 – 1480nm SLED 1+2+3+4 – 1580nm | B_{FWHM} | CW $T_{OP} = 25^{\circ}C$ $T_{TEC} = 21^{\circ}C I_{OP}$ | - | 55 45 60 50 290 | - | nm |
| Bandwidth @-10dB SLED 1 – 1680nm SLED 2 – 1615nm SLED 3 – 1550nm SLED 4 – 1480nm SLED 1+2+3+4 – 1580nm | $B_{@10dB}$ | CW $T_{OP} = 25^{\circ}C$ $T_{TEC} = 21^{\circ}C I_{OP}$ | - | 90 75 90 85 310 | - | nm |
| Spectral Coverage | SC | CW $T_{OP} = 25^{\circ}C$ $T_{TEC} = 21^{\circ}C I_{OP}$ | - | 1435- 1725 | - | nm |
| Spectrum Ripple (see note 8) SLED 1 – 1680nm SLED 2 – 1615nm SLED 3 – 1550nm SLED 4 – 1480nm | R | CW $T_{OP} = 25^{\circ}C$ $T_{TEC} = 21^{\circ}C$ | < 0.15 | < 0.30 | 0.5 0.35 0.5 0.45 | dB |
| Polarization Extinction Ratio (see note 9) | PER | CW $T_{OP} = 25^{\circ}C$ $T_{TEC} = 21^{\circ}C I_{OP}$ | 10 | - | - | dB |
| RIN | RIN | | - | < -130 | - | dB/Hz |

| | | | | | | |
|---------------------------------|-------------|---|-----|------|------|------------|
| Thermistor Resistance TEC | R_{THTEC} | $T_{OP} = 25^{\circ}C$ $T_{TEC} = 21^{\circ}C$ | 9.5 | 10.0 | 10.5 | k Ω |
| Power Dissipation (see note 10) | P_{DISS} | I_{OP} | - | 11 | - | W |
| TEC Voltage | V_{TEC} | | - | - | 9 | V |
| TEC Current | I_{TEC} | | - | - | 10 | A |

Notes:

5. There may be differences in typical values of output power, power stability, wavelength and bandwidth, due to coupling efficiency. These values are references and there is no guarantee that each particular OSE2 module will have EXACTLY the typical values shown on the previous chart. The specification lists the operating temperature for the electrical/optical characteristics, which is the temperature of the OSE2 during the time that the specifications were measured. Variation in temperature beyond what is specified can have a significant effect on the optical characteristics, like changes in wavelength or drop in output power.
6. Center Wavelength is defined as the center point of the 3dB bandwidth of each individual SLED.
7. BeST-SLED FWHM is defined as the bandwidth from the lowest spectral dip, when all the SLEDs are on.
8. Resolution of 0.1nm. Figure of merit does not include dips between SLEDs.
9. Polarization Extinction Ratio is defined as the ratio of optical powers of perpendicular polarizations, expressed in decibels (dB).
10. Power dissipation when all SLEDs are on and $|T_{OSE2} - T_{TEC}|$ is 40°C.

F. PLOTS - Test performed at $T_{OP}=25^{\circ}C$ and $T_{TEC}=21^{\circ}C$

FIG. 1: OSE2 SPECTRUM

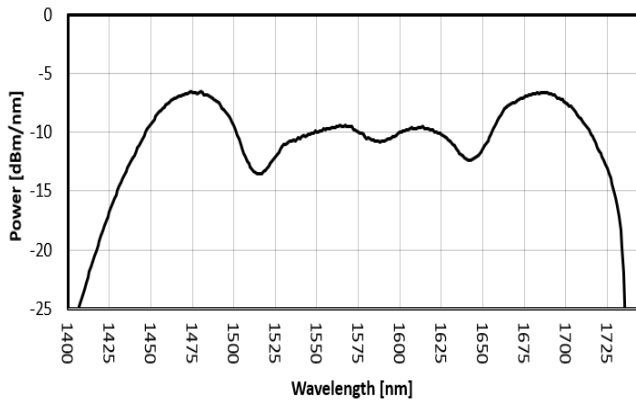

FIG. 2: SLED 1 SPECTRUM

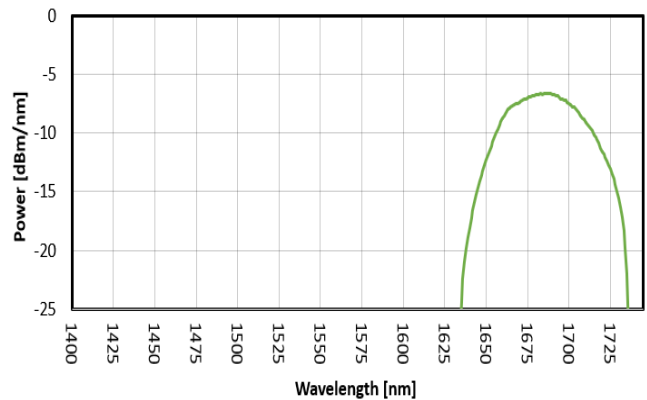

FIG. 3: SLED 2 SPECTRUM

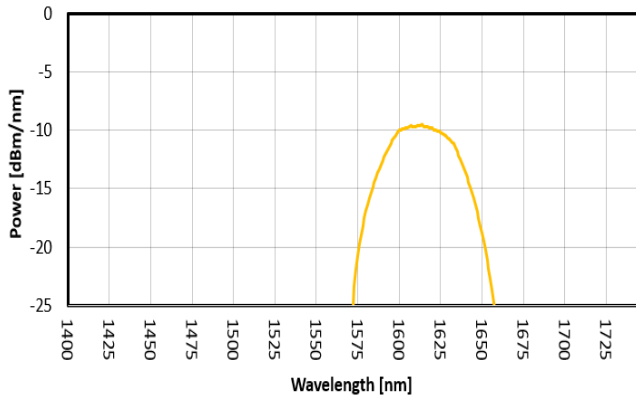

FIG. 4: SLED 3 SPECTRUM

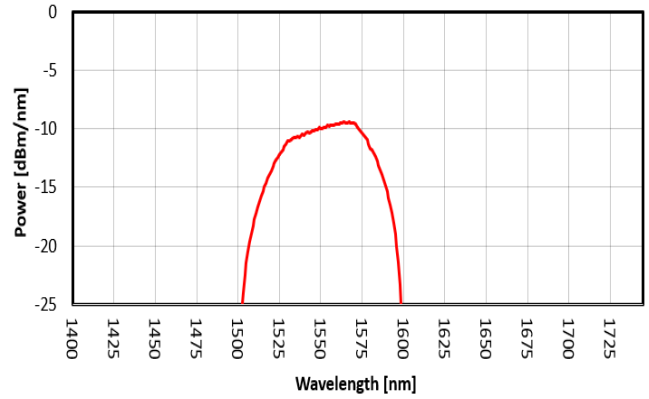

FIG. 5: SLED 4 SPECTRUM

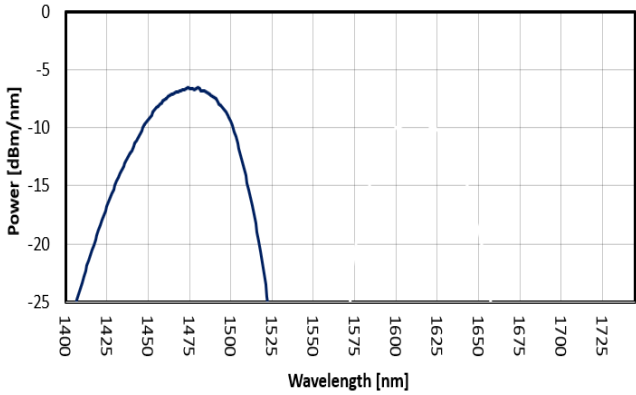

FIG. 6: SLED 1 OUTPUT POWER VS CURRENT

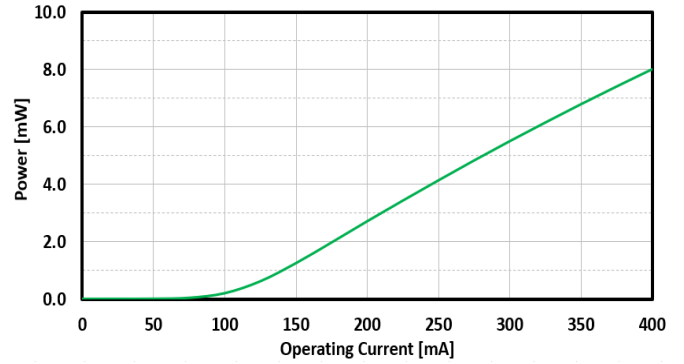

FIG. 7: SLED 2 OUTPUT POWER VS CURRENT

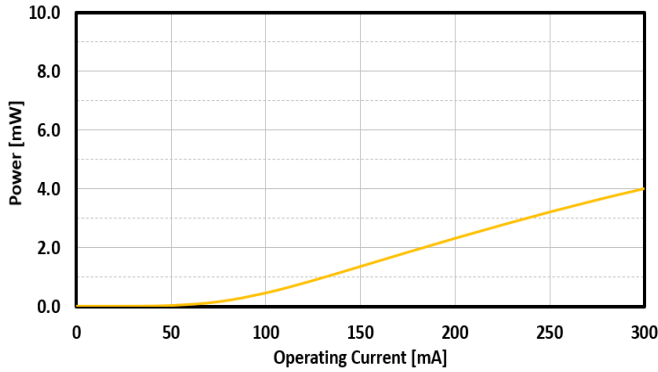

FIG. 8: SLED 3 OUTPUT POWER VS CURRENT

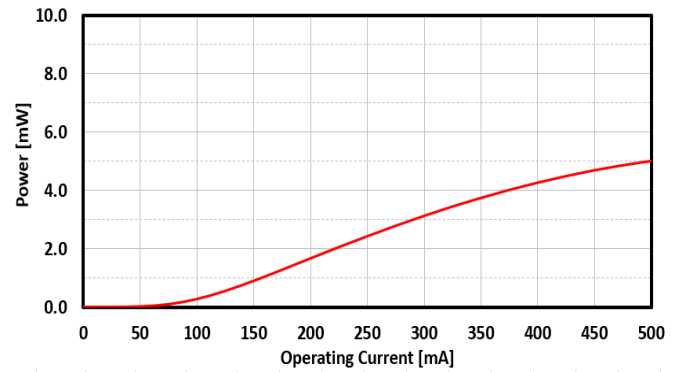

FIG. 9: SLED 4 OUTPUT POWER VS CURRENT

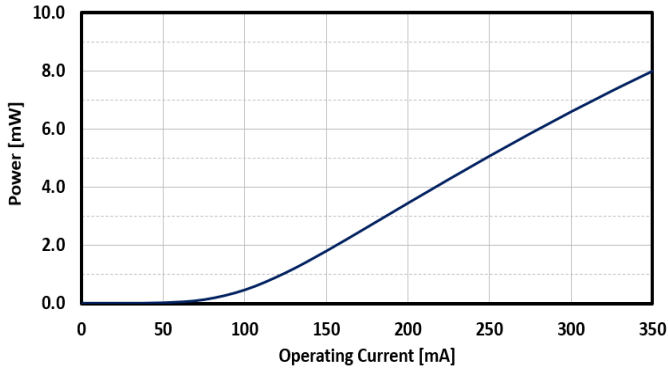

FIG. 10: SLED 1 FORWARD VOLTAGE VS CURRENT

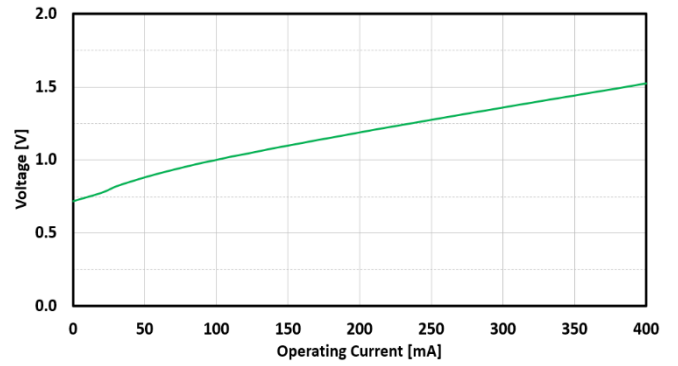

FIG. 11: SLED 2 FORWARD VOLTAGE VS CURRENT

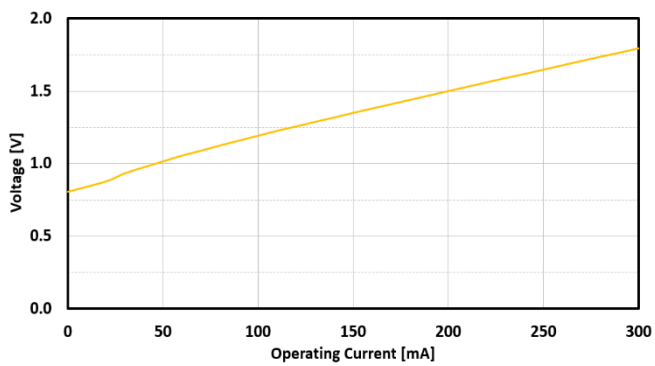

FIG. 12: SLED 3 FORWARD VOLTAGE VS CURRENT

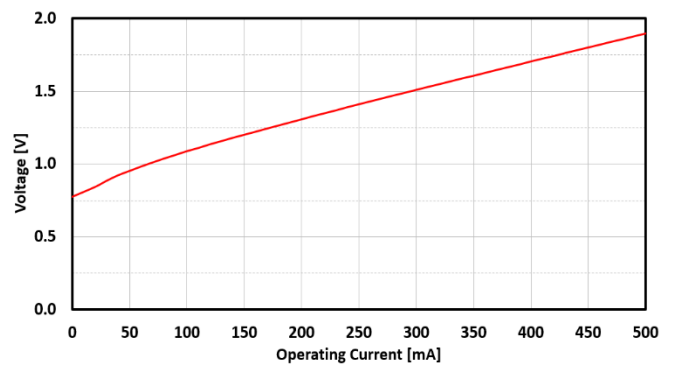

FIG. 13: SLED 4 FORWARD VOLTAGE VS CURRENT

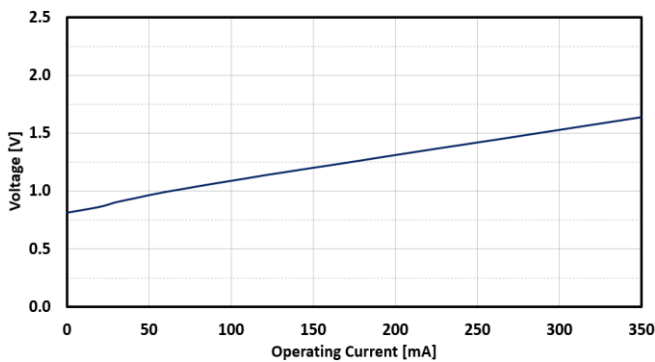
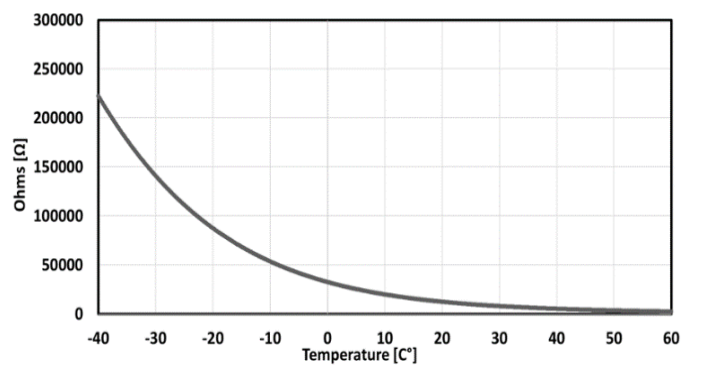
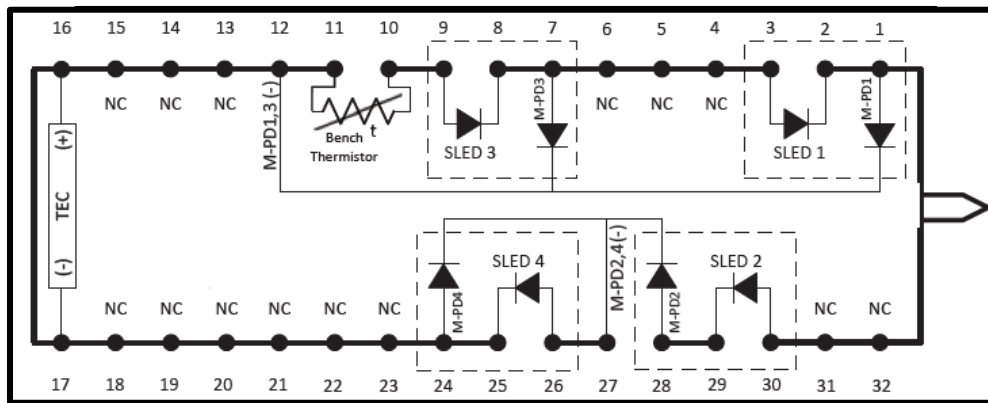

FIG. 14: THERMISTOR R_{THTEC} RESISTANCE VS TEMPERATURE



G. PIN OUT

| External Pin Assignment – BeST-SLED: 4 SLEDs | | | | | | | |
|--|------------|----|-------------|----|-----------|----|-------------|
| 1 | M-PD1 (+) | 9 | SLED 3(+) | 17 | TEC (-) | 25 | SLED 4 (-) |
| 2 | SLED 1 (-) | 10 | Thermistor | 18 | NC | 26 | SLED 4 (+) |
| 3 | SLED 1 (+) | 11 | Thermistor | 19 | NC | 27 | M-PD2,4 (-) |
| 4 | NC | 12 | M-PD1,3 (-) | 20 | NC | 28 | M-PD2 (+) |
| 5 | NC | 13 | NC | 21 | NC | 29 | SLED 2 (-) |
| 6 | NC | 14 | NC | 22 | NC | 30 | SLED 2 (+) |
| 7 | M-PD3 (+) | 15 | NC | 23 | NC | 31 | NC |
| 8 | SLED 3 (-) | 16 | TEC (+) | 24 | M-PD4 (+) | 32 | NC |



H. MECHANICAL DIAGRAM

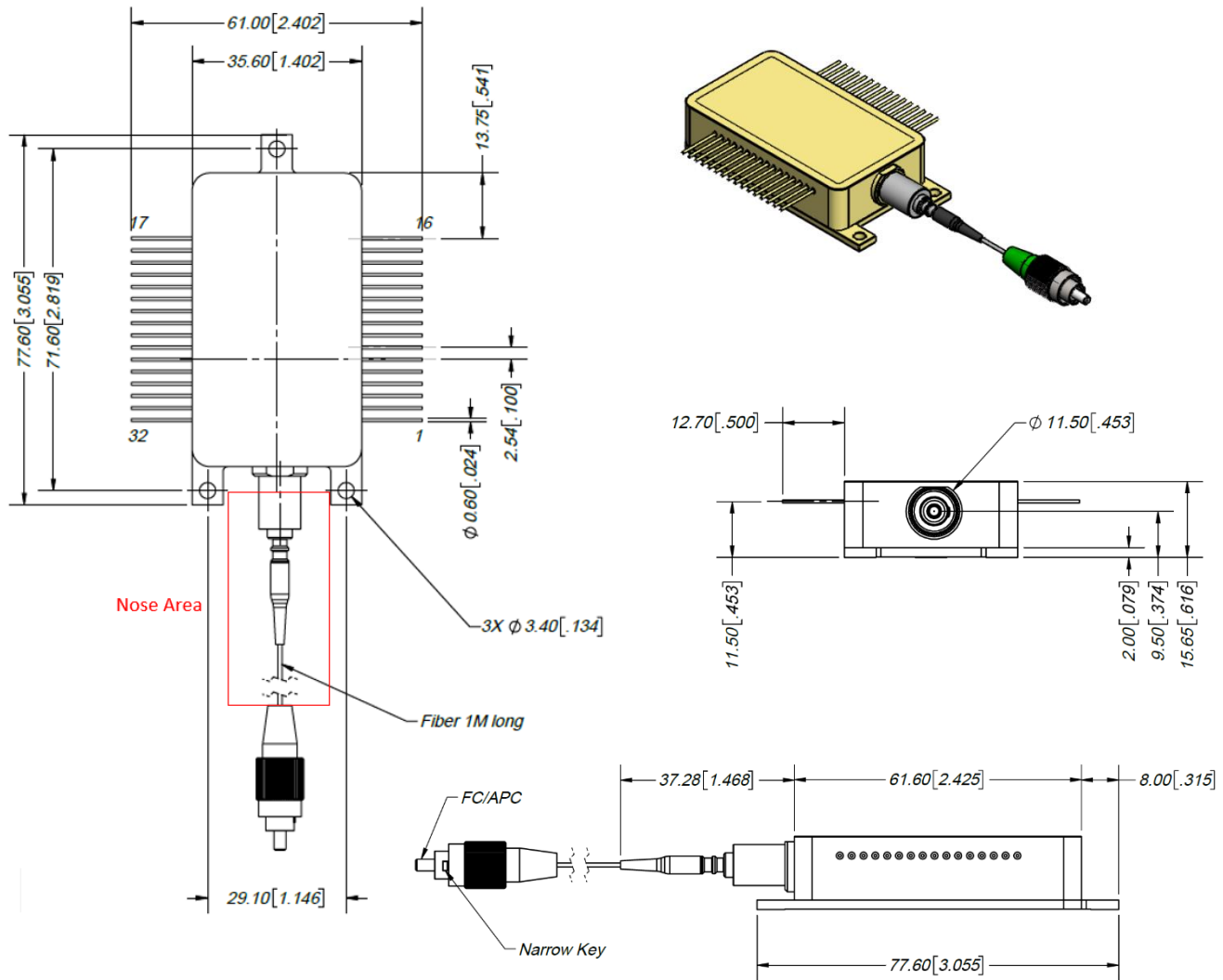

I. MOUNTING RECOMMENDATIONS:

The OSE2 can be mounted on a flat cooling surface without having to risk forming the pins. Mounting surface should be flat, with no physical obstructions underneath to cause any discontinuity in the surface flatness. If a heatsink is used, the base of the butterfly package will rest on the surface of a heatsink in order to cool the internal TEC.

Use only the 3mm mounting holes in the case of the BeST-SLED, Luxmux recommends the use of 18-8 Stainless Steel Socket Head Screw 5-40 Thread Size screws. Maximum torque to avoid damage to the device is 13 lb.in. /1.5 Nm. Minimum torque is 9 lb.in/1.1 Nm. Do not use self-tapping screws.

The OSE2 Light Source should be mounted so that mechanical vibrations cannot cause short circuits between leads. AZIMUTH 16 pin, 0.100" pitch Sockets are recommended. The 32 pins will rest on a pair of spring-loaded sockets and be squeezed between the contacts and a plastic clamp.



J. SAFETY

All statements regarding safety of operation and technical data will only apply when the unit is operated correctly.

The driver must not be operated in environments susceptible to explosion hazards. Do not obstruct the air ventilation slots. If any parts of the driver, or electronics are broken or exposed, contact Luxmux technical support and do not attempt to operate the unit.

The OSE2 is a Class 1M laser product. It is safe for all conditions of use except when passed through magnifying optics such as microscopes and telescopes. It produces a beam that is divergent. If light is re-focused use protective eye wear.

K. ORDERING CODE

| ORDERING CODE: | | LTC | OSE2 | SLEDS | FT | DOP | SC | FWHM | CW | LOP |
|----------------|---|-----|------|-------|----|-----|----|------|----|-----|
| LTC | Luxmux Technology Corporation | | | | | | | | | |
| OSE2 | Best-SLED® OSE G2 | | | | | | | | | |
| SLEDS | SLED center wavelength, choose from one of the models in the table 1300nm, 1340nm, 1390nm, 1430nm, 1480nm, 1550nm, 1615nm, 1680nm [choose up to 6] | | | | | | | | | |
| FT | Fiber Type, choose 1: PM: Polarization Maintaining SM: Single Mode FS: Free Space | | | | | | | | | |
| DOP | HP: High Degree of Polarization | | | | | | | | | |
| SC | Spectral Coverage [nm] | | | | | | | | | |
| FWHM | Full Width Half Maximum [nm] (FWHM defined as the bandwidth from the lowest spectral dip) | | | | | | | | | |
| CW | Center Wavelength [nm] | | | | | | | | | |
| LOP | Light Output Power [mW] | | | | | | | | | |

| |
|-------------------|
| Product Code |
| Available Options |
| Taken From Table |

#LTC-OSE2-1480_1550_1615_1680-PM-HP-1435_1725-290-1580-25_DS_2021_08_05

This document is the property of Luxmux, and contains proprietary information. Luxmux reserves the right to make product design or specification changes without notice.



Redefining Spectral Boundaries

| Part Number | Ordering Code: LTC-OSE2-(SLEDS)-(FT)-(DOP)-(SC)-(FWHM)-(CW)-(LOP) | SLEDS [nm] | FT | SC [nm] | FWHM [nm] | CW [nm] | LOP [mW] |
|-------------|--|------------------------------------|----|-------------|-----------|---------|----------|
| ASM000001 | LTC-OSE2-1615_1680-PM-HP-1575_1725-150-1650-12 | 1615, 1680 | PM | 1575 - 1725 | 150 | 1650 | 12 |
| ASM000002 | LTC-OSE2-1480_1550_1615-PM-HP-1435_1640-205-1538-18 | 1480, 1550, 1615 | PM | 1435 - 1640 | 205 | 1538 | 18 |
| ASM000003 | LTC-OSE2-1340_1390_1430-PM-HP-1310_1465-155-1388-20 | 1340, 1390, 1430 | PM | 1310 - 1465 | 155 | 1388 | 20 |
| ASM000004 | LTC-OSE2-1300_1340_1390_1430-PM-HP-1265_1465-200-1365-25 | 1300, 1340, 1390, 1430 | PM | 1265 - 1465 | 200 | 1365 | 25 |
| ASM000005 | LTC-OSE2-1480_1550_1615_1680-PM-HP-1435_1725-290-1580-25 | 1480, 1550, 1615, 1680 | PM | 1435 - 1725 | 290 | 1580 | 25 |
| ASM000006 | LTC-OSE2-1300_1340_1390_1430_1480-PM-HP-1265_1500-235-1383-35 | 1300, 1340, 1390, 1430, 1480 | PM | 1265 - 1500 | 235 | 1383 | 35 |
| ASM000007 | LTC-OSE2-1340_1390_1430_1480_1550-PM-HP-1305_1605-300-1455-35 | 1340, 1390, 1430, 1480, 1550 | PM | 1305 - 1605 | 300 | 1455 | 35 |
| ASM000008 | LTC-OSE2-1300_1390_1480_1550_1615_1680-PM-HP-1265_1725-460-1495-40 | 1300, 1390, 1480, 1550, 1615, 1680 | PM | 1265 - 1725 | 460 | 1495 | 40 |
| ASM000009 | LTC-OSE2-1480_1550-PM-HP-1435_1605-170-1520-12 | 1480, 1550 | PM | 1435 - 1605 | 170 | 1520 | 12 |
| ASM000010 | LTC-OSE2-1340_1390_1430_1480_1550_1615-PM-HP-1310_1640-330-1475-38 | 1340, 1390, 1430, 1480, 1550, 1615 | PM | 1310 - 1640 | 330 | 1475 | 38 |
| ASM000011 | LTC-OSE2-1300_1340_1390_1430_1480_1550-PM-HP-1265_1605-340-1435-40 | 1300, 1340, 1390, 1430, 1480, 1550 | PM | 1265 - 1605 | 340 | 1435 | 40 |
| ASM000012 | LTC-OSE2-1430_1480_1550-PM-HP-1410_1605-195-1508-19 | 1430, 1480, 1550 | PM | 1410 - 1605 | 195 | 1508 | 19 |
| ASM000013 | LTC-OSE2-1300_1340_1390-PM-HP-1265_1420-155-1343-20 | 1300, 1340, 1390 | PM | 1265 - 1420 | 155 | 1343 | 20 |
| ASM000014 | LTC-OSE2-1390_1430_1480-PM-HP-1355_1500-145-1428-19 | 1390, 1430, 1480 | PM | 1355 - 1500 | 145 | 1428 | 19 |
| ASM000015 | LTC-OSE2-1550_1615_1680-PM-HP-1515_1725-210-1620-18 | 1550, 1615, 1680 | PM | 1515 - 1725 | 210 | 1620 | 18 |
| ASM000016 | LTC-OSE2-1300_1340-PM-HP-1265_1365-100-1315-12 | 1300, 1340 | PM | 1265 - 1365 | 100 | 1315 | 12 |
| ASM000017 | LTC-OSE2-1390_1480_1550-PM-HP-1340_1610-270-1475-20 | 1390, 1480, 1550 | PM | 1340 - 1610 | 270 | 1475 | 20 |
| ASM000018 | LTC-OSE2-1300_1390_1480-PM-HP-1265_1500-235-1383-20 | 1300, 1390, 1480 | PM | 1265 - 1500 | 235 | 1383 | 20 |
| ASM000019 | LTC-OSE2-1390_1480_1550_1615_1680-PM-HP-1340_1725-385-1533-32 | 1390, 1480, 1550, 1615, 1680 | PM | 1340 - 1725 | 385 | 1533 | 32 |
| ASM000020 | LTC-OSE2-1550_1615-PM-HP-1530_1630-100-1580-10 | 1550, 1615 | PM | 1530 - 1630 | 100 | 1580 | 10 |

| Part Number | Ordering Code: LTC-OSE2-(SLEDS)-(FT)-(DOP)-(SC)-(FWHM)-(CW)-(LOP) | SLEDS [nm] | FT | SC [nm] | FWHM [nm] | CW [nm] | LOP [mW] |
|-------------|--|------------------------------------|----|-------------|-----------|---------|----------|
| ASM000101 | LTC-OSE2-1615_1680-SM-HP-1575_1725-150-1650-12 | 1615, 1680 | SM | 1575 - 1725 | 150 | 1650 | 12 |
| ASM000102 | LTC-OSE2-1480_1550_1615-SM-HP-1435_1640-205-1538-18 | 1480, 1550, 1615 | SM | 1435 - 1640 | 205 | 1538 | 18 |
| ASM000103 | LTC-OSE2-1340_1390_1430-SM-HP-1310_1465-155-1388-20 | 1340, 1390, 1430 | SM | 1310 - 1465 | 155 | 1388 | 20 |
| ASM000104 | LTC-OSE2-1300_1340_1390_1430-SM-HP-1265_1465-200-1365-25 | 1300, 1340, 1390, 1430 | SM | 1265 - 1465 | 200 | 1365 | 25 |
| ASM000105 | LTC-OSE2-1480_1550_1615_1680-SM-HP-1435_1725-290-1580-25 | 1480, 1550, 1615, 1680 | SM | 1435 - 1725 | 290 | 1580 | 25 |
| ASM000106 | LTC-OSE2-1300_1340_1390_1430_1480-SM-HP-1265_1500-235-1383-35 | 1300, 1340, 1390, 1430, 1480 | SM | 1265 - 1500 | 235 | 1383 | 35 |
| ASM000107 | LTC-OSE2-1340_1390_1430_1480_1550-SM-HP-1305_1605-300-1455-35 | 1340, 1390, 1430, 1480, 1550 | SM | 1305 - 1605 | 300 | 1455 | 35 |
| ASM000108 | LTC-OSE2-1300_1390_1480_1550_1615_1680-SM-HP-1265_1725-460-1495-40 | 1300, 1390, 1480, 1550, 1615, 1680 | SM | 1265 - 1725 | 460 | 1495 | 40 |
| ASM000109 | LTC-OSE2-1480_1550-SM-HP-1435_1605-170-1520-12 | 1480, 1550 | SM | 1435 - 1605 | 170 | 1520 | 12 |
| ASM000110 | LTC-OSE2-1340_1390_1430_1480_1550_1615-SM-HP-1310_1640-330-1475-38 | 1340, 1390, 1430, 1480, 1550, 1615 | SM | 1310 - 1640 | 330 | 1475 | 38 |
| ASM000111 | LTC-OSE2-1300_1340_1390_1430_1480_1550-SM-HP-1265_1605-340-1435-40 | 1300, 1340, 1390, 1430, 1480, 1550 | SM | 1265 - 1605 | 340 | 1435 | 40 |
| ASM000112 | LTC-OSE2-1430_1480_1550-SM-HP-1410_1605-195-1508-19 | 1430, 1480, 1550 | SM | 1410 - 1605 | 195 | 1508 | 19 |
| ASM000113 | LTC-OSE2-1300_1340_1390-SM-HP-1265_1420-155-1343-20 | 1300, 1340, 1390 | SM | 1265 - 1420 | 155 | 1343 | 20 |
| ASM000114 | LTC-OSE2-1390_1430_1480-SM-HP-1355_1500-145-1428-19 | 1390, 1430, 1480 | SM | 1355 - 1500 | 145 | 1428 | 19 |
| ASM000115 | LTC-OSE2-1550_1615_1680-SM-HP-1515_1725-210-1620-18 | 1550, 1615, 1680 | SM | 1515 - 1725 | 210 | 1620 | 18 |
| ASM000116 | LTC-OSE2-1300_1340-SM-HP-1265_1365-100-1315-12 | 1300, 1340 | SM | 1265 - 1365 | 100 | 1315 | 12 |
| ASM000117 | LTC-OSE2-1390_1480_1550-SM-HP-1340_1610-270-1475-20 | 1390, 1480, 1550 | SM | 1340 - 1610 | 270 | 1475 | 20 |
| ASM000118 | LTC-OSE2-1300_1390_1480-SM-HP-1265_1500-235-1383-20 | 1300, 1390, 1480 | SM | 1265 - 1500 | 235 | 1383 | 20 |
| ASM000119 | LTC-OSE2-1390_1480_1550_1615_1680-SM-HP-1340_1725-385-1533-32 | 1390, 1480, 1550, 1615, 1680 | SM | 1340 - 1725 | 385 | 1533 | 32 |
| ASM000120 | LTC-OSE2-1550_1615-SM-HP-1530_1630-100-1580-10 | 1550, 1615 | SM | 1530 - 1630 | 100 | 1580 | 10 |

#LTC-OSE2-1480_1550_1615_1680-PM-HP-1435_1725-290-1580-25_DS_2021_08_05

This document is the property of Luxmux, and contains proprietary information. Luxmux reserves the right to make product design or specification changes without notice.



Redefining Spectral Boundaries

| Part Number | Ordering Code: LTC-OSE2-(SLEDs)-(FT)-(DOP)-(SC)-(FWHM)-(CW)-(LOP) | SLEDs [nm] | FT | SC [nm] | FWHM [nm] | CW [nm] | LOP [mW] |
|-------------|---|------------------------------------|----|-------------|-----------|---------|----------|
| ASM000201 | LTC-OSE2-1615_1680-FS-HP-1575_1725-150-1650-35 | 1615, 1680 | FS | 1575 – 1725 | 150 | 1650 | 35 |
| ASM000202 | LTC-OSE2-1480_1550_1615-FS-HP-1435_1640-205-1538-55 | 1480, 1550, 1615 | FS | 1435 – 1640 | 205 | 1538 | 55 |
| ASM000203 | LTC-OSE2-1340_1390_1430-FS-HP-1310_1465-155-1388-65 | 1340, 1390, 1430 | FS | 1310 – 1465 | 155 | 1388 | 65 |
| ASM000204 | LTC-OSE2-1300_1340_1390_1430-FS-HP-1265_1465-200-1365-90 | 1300, 1340, 1390, 1430 | FS | 1265 – 1465 | 200 | 1365 | 90 |
| ASM000205 | LTC-OSE2-1480_1550_1615_1680-FS-HP-1435_1725-290-1580-80 | 1480, 1550, 1615, 1680 | FS | 1435 – 1725 | 290 | 1580 | 80 |
| ASM000206 | LTC-OSE2-1300_1340_1390_1430_1480-FS-HP-1265_1500-235-1383-115 | 1300, 1340, 1390, 1430, 1480 | FS | 1265 – 1500 | 235 | 1383 | 115 |
| ASM000207 | LTC-OSE2-1340_1390_1430_1480_1550-FS-HP-1305_1605-300-1455-110 | 1340, 1390, 1430, 1480, 1550 | FS | 1305 – 1605 | 300 | 1455 | 110 |
| ASM000208 | LTC-OSE2-1300_1390_1480_1550_1615_1680-FS-HP-1265_1725-460-1495-125 | 1300, 1390, 1480, 1550, 1615, 1680 | FS | 1265 – 1725 | 460 | 1495 | 125 |
| ASM000209 | LTC-OSE2-1480_1550-FS-HP-1435_1605-170-1520-45 | 1480, 1550 | FS | 1435 – 1605 | 170 | 1520 | 45 |
| ASM000210 | LTC-OSE2-1340_1390_1430_1480_1550_1615-FS-HP-1310_1640-330-1475-120 | 1340, 1390, 1430, 1480, 1550, 1615 | FS | 1310 – 1640 | 330 | 1475 | 120 |
| ASM000211 | LTC-OSE2-1300_1340_1390_1430_1480_1550-FS-HP-1265_1605-340-1435-130 | 1300, 1340, 1390, 1430, 1480, 1550 | FS | 1265 – 1605 | 340 | 1435 | 130 |
| ASM000212 | LTC-OSE2-1430_1480_1550-FS-HP-1410_1605-195-1508-60 | 1430, 1480, 1550 | FS | 1410 – 1605 | 195 | 1508 | 60 |
| ASM000213 | LTC-OSE2-1300_1340_1390-FS-HP-1265_1420-155-1343-70 | 1300, 1340, 1390 | FS | 1265 – 1420 | 155 | 1343 | 70 |
| ASM000214 | LTC-OSE2-1390_1430_1480-FS-HP-1355_1500-145-1428-65 | 1390, 1430, 1480 | FS | 1355 – 1500 | 145 | 1428 | 65 |
| ASM000215 | LTC-OSE2-1550_1615_1680-FS-HP-1515_1725-210-1620-55 | 1550, 1615, 1680 | FS | 1515 – 1725 | 210 | 1620 | 55 |
| ASM000216 | LTC-OSE2-1300_1340-FS-HP-1265_1365-100-1315-50 | 1300, 1340 | FS | 1265 – 1365 | 100 | 1315 | 50 |
| ASM000217 | LTC-OSE2-1390_1480_1550-FS-HP-1340_1610-270-1475-60 | 1390, 1480, 1550 | FS | 1340 – 1610 | 270 | 1475 | 60 |
| ASM000218 | LTC-OSE2-1300_1390_1480-FS-HP-1265_1500-235-1383-70 | 1300, 1390, 1480 | FS | 1265 – 1500 | 235 | 1383 | 70 |
| ASM000219 | LTC-OSE2-1390_1480_1550_1615_1680-FS-HP-1340_1725-385-1533-100 | 1390, 1480, 1550, 1615, 1680 | FS | 1340 – 1725 | 385 | 1533 | 100 |
| ASM000220 | LTC-OSE2-1550_1615-FS-HP-1530_1630-100-1580-30 | 1550, 1615 | FS | 1530 – 1630 | 100 | 1580 | 30 |

#LTC-OSE2-1480_1550_1615_1680-PM-HP-1435_1725-290-1580-25_DS_2021_08_05

This document is the property of Luxmux, and contains proprietary information. Luxmux reserves the right to make product design or specification changes without notice.