

LBX-647

Laser Diode

Optical characteristics *

Emission wavelength	647 nm (-1/+4 nm)	
Linewidth	≤ 1.2 nm	
Output power	Free space	Fiber coupled
	140 mW	95 mW
Control mode(s)	Automatic Power Control (APC) Automatic Current Control (ACC)	
Power stability over 8 hours and within ±3k	± 0.5%	
Power adjustment range	0 - 100%	
Optical noise %RMS, 10Hz - 2 MHz bandwidth	≤ 0.2%	

— Transverse singlemode free-space beam

Beam waist diameter (typ) at 1/e ² , 50mm from output aperture	1 mm
Beam divergence at 1/e ² , full angle, in far field	≤ 1.3 mrad
Beam quality factor (M²)	≤ 1.25
Beam circularity, in far field	≥ 90%
Polarization extinction ratio (typ)	100:1
Polarization state	linear, vertical at +/-5°

— Modulation functions

Digital Modulation

Max modulation frequency	150 MHz
Rise/fall time, 10%-90%	≤ 2 ns

Analog Modulation

Bandwidth 3dB cut-off frequency, ACC mode	≥ 3 MHz
Rise/fall time, 10%-90%	≤ 150 ns

Fiber coupling option

	SM and PM Fiber	MM Fiber (50 μm, 0.22 NA)
Coupling Efficiency	≥ 70%	≥ 80%
Polarization Ratio (PMF only)	100 : 1	n/a
Fiber Output Connector	FC-APC FC/PC, FCP8 on demand	FC-APC
Power stability over 8 hours and within ±3k	±2%	±2%
Fiber length	2.0 m	2.0 m



Mechanical drawings

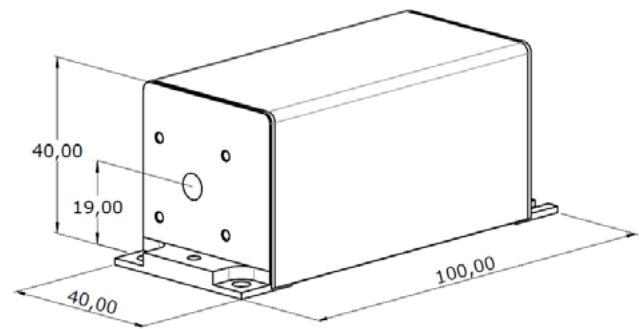

— Plug and Play version provided with :

- ControlBoxx
- Power supply

Options

- Electro-mechanical shutter
- Heat sink
- Clean-up filter

General specifications

	Plug and Play version	OEM version
Compliance	CE FDA 21 CFR 1040.10/1040.11	FDA 21 CFR 1040.10 / 1040.11
Operating temperature	10 - 38°C ambient air with optional heat sink	10 - 50°C baseplate
Power consumption	≤ 25 W	≤ 10 W
Storage temperature	0 to 60°C	
Supply voltage	100 to 240 VAC external power supply	5 to 12 VDC
Warm-up time	≤ 2 minutes	
Interfaces	USB, RS-232, dedicated electronic interface	

Warranty : 12 months from shipment date

*Specifications at nominal power



CONTACT US

Oxxius S.A
4 rue Louis de Broglie
F-22300 Lannion, France

Phone : +33 296 48 70 28
sales@oxxius.com
www.oxxius.com